



## Flexible Fast Charger (Mode 2 Charging Cable)



# Flexible Fast Charger (Mode 2 Charging Cable) Instructions for use

## Contents

Information	4
Operating	9
Installation (Optional accessory)	15
Troubleshooting	16
Environmental specifications	18
Disposal	18
Certification/Compliance	18

# Information

## Symbols used in this document



Denotes instructions that draw your attention to dangers.



Denotes instructions that draw your attention to special features.

◀ Denotes the end of the instruction or other text.

## Safety information

Read the information carefully and look at the device to familiarise yourself with it before you attempt to install, operate or service it. Use only for charging BMW, MINI or Rolls-Royce vehicles.



**RISK OF FIRE OR ELECTRIC SHOCK CAUTION:** Always ensure that the electrical power connection complies with the national statutory regulations. To reduce the risk of fire, use the device only with a sufficiently dimensioned circuit breaker. Increased ambient temperatures in the control cabinet must also be taken into consideration. In certain circumstances, it may require a reduction in the charging current to increase the system availability. ◀



## Safety information

- Children should be supervised when in the vicinity of Flexible Fast Charger when it is connected.
- Clean the charging device only with a dry cloth. Make sure it is disconnected from the power grid and vehicle. Do not use any cleaning supplies or flammable solvents, such as alcohol or benzene.
- Do not use Flexible Fast Charger with damaged outlet, cable or housing. Ensure that the contact area is not close to heat sources, dirt or water.
- Do not use the device at potentially explosive atmosphere areas.
- Do not disconnect the mains adapter cable while it is in charging session.
- Do not put your fingers into the connector.
- Do not use Flexible Fast Charger with an extension cord, cable drum, multiple sockets, travel adapters, timers and any adapter of vehicle connector.
- Do not make any unauthorized changes or modifications to Flexible Fast Charger.
- Repair work to Flexible Fast Charger shall only be performed by the manufacturer.
- Do not remove any identifiers such as safety symbols, warning instructions, labels or cable markings.
- Do not use Flexible Fast Charger if mains adapter is not plugged into domestic outlet completely.
- Do not connect to any other loads, electric tools, etc.
- Do not drop Flexible Fast Charger and adapter cable.
- Do not drive over Flexible Fast Charger or adapter.
- Do not put device under water.
- Do not bend the cables.
- Do not use the below listed mains adapter cables with any other In-Cable-Control-Boxes.
- Do not run over Flexible Fast Charger, adapter cables and plugs.
- For the safe transportation in the car, use the provided bag and fasten it at your anchoring refer to Safety Guide for safe placement.
- Must disconnect the mains adapter from domestic outlet while assembling.
- Never use defective, worn or dirty mains adapter cable or vehicle connector.
- Pull Flexible Fast Charger out of the domestic outlet by the adapter instead of cable . ◀

## Infrastructure information

- The Flexible Fast Charger is not limited when delivered. Please ensure the electrical installation is capable of handling the voltage/amperage requirements ahead of usage and if needed, activate the power limitation in the charging settings of your BMW/MINI/RR vehicle.
- The device is designed for use with a selection of electrical outlets. These electrical outlets must comply with the relevant national regulations (connection and installation standards) whether they are already existing or installed separately.
- Ensure that the maximum permissible charging current suits the installed circuit breaker and the back-up fuse.
- Ensure that an already existing wall installation and outlet is designed for permanent electrical load. It is highly recommended that the device is connected to an electrical outlet with a separate residual-current-operated circuit breaker. No other circuits should be connected to this residual-current-operated circuit breaker.
- All electrical outlets must be installed, commissioned and serviced by appropriately trained, qualified and authorized electricians, with the knowledge of the relevant standards, who bear full responsibility for compliance with current standards and installation regulations.
- This device must have access to an earth connection. In the event of an error, the earth connection will reduce the danger of an electric shock. Please ensure that the electrical outlet can provide a sufficiently designed earth connection.

## Intended use

The intended use of the device in every case includes compliance with the ambient conditions for which this device was developed.

The instructions contained in manual must be followed to the letter. Otherwise sources of danger may be created or safety equipment may be rendered inoperable. In addition to the safety information, the safety and accident prevention regulations relating to the specific device must be followed.

## **About this manual**

This manual and functions described are valid for Mode 2 charging devices of the following type:

Flexible Fast Charger

The illustrations and explanations contained in this manual refer to a typical version of device. Your device version may differ from this. This manual is aimed at the target groups, e.g. End customers (users of Flexible Fast Charger).

## **Warranty**

Service can provide more information in terms of the warranty. However, the following cases are not covered:

- Defects or damage caused by installation work not as specified in the installation instructions and the product not being used as specified in the manual.
- Costs and damage caused by repair work not carried out by a specialist electrician authorized by sales outlet or authorized service workshop.

## Scope of delivery

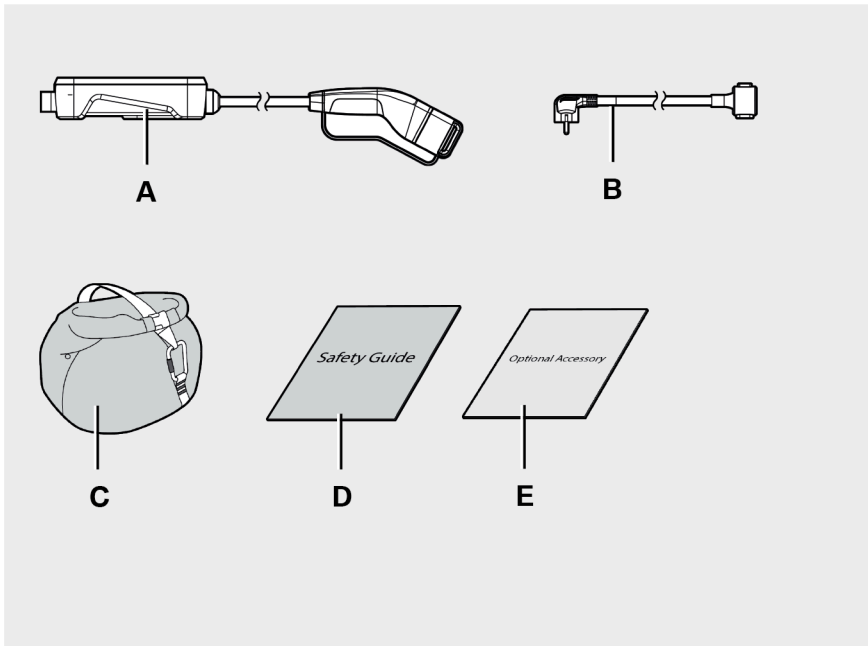

I01 0039 V

- A Function box with vehicle connector
- B Mains adapter cable
- C Bag
- D Safety guide
- E Optional accessory



# Operating

## Overview

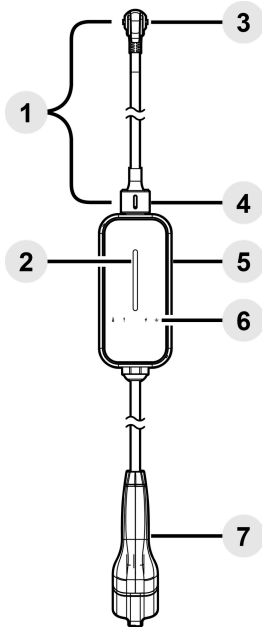

1. Mains adapter cable
2. Charging status bar
3. Mains adapter
4. Mains interface with adapter cap
5. Function box (ICCB: In-Cable-Control-Box)
6. LED indicator
7. Vehicle connector (Type 2)

## LED indicator



Temperature



Internal error



Mains voltage



Ground detection

## Start charging

1. Connect the chosen mains adapter cable to Flexible Fast Charger.
2. Connect the mains adapter to a domestic outlet.
3. When the mains adapter is connected to domestic outlet, the charging status bar will flash orange, then illuminate blue, indicating Flexible Fast Charger is ready for charging.
4. Connect the vehicle connector to EV (Electric vehicle) inlet, charging session will start automatically and charging status bar flashes blue.



- EV shall be parked close enough to the domestic outlet for connection.
- Ensure Flexible Fast Charger will not be stepped on to avoid damage. ◀

## Stop charging









1. Stop charging session at the EV.
2. Disconnect the vehicle connector from the EV inlet.
3. Remove the mains adapter from the domestic outlet.







- Disconnection abnormally or disconnection under load with domestic outlet, Flexible Fast Charger could be damaged or the situation could be dangerous to people. ◀

## Mains adapter cables for international available plugs

The Flexible Fast Charger can be used with various kinds of below mains adapters to charge wherever you are and as fast as possible. Please check the additional adapters list available as optional accessory for further information.

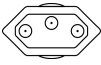
Plug Type	Type E+F	Type E+F	Type E+F	Type G	Type G	Type J	Type K	Type N
								
Max rating / Max charging power	8A / 1.8kW	10A / 2.3kW	10A / 2.3kW	10A / 2.3kW	10A / 2.3kW	8A / 1.8kW	6A / 1.3kW	8A / 1.8kW
TT/TN system	X	X		X		X	X	X
IT system*			X		X			

\*IT earthing system: No ground monitoring (e. g. Norway). IT Mains adapter cables are labelled with a yellow marking.

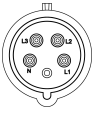
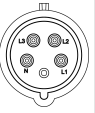
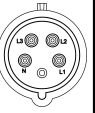
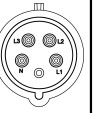
Plug Type	Type N	TIS 166-2549	CEE 16A (blue, 1 phase)	CEE 16A (blue, 1 phase)	CEE 16A (red, 3 phase)	CEE 16A (red, 3 phase)	CEE 32A (red, 3 phase)	CEE 32A (red, 3 phase)
								
Max rating / Max charging power	16A / 3.6kW	10A / 2.3kW	16A / 3.6kW	16A / 3.6kW	16A / 11kW	16A / 11kW	16A / 11kW	16A / 11kW
TT/TN system	X	X	X		X		X	
IT system*				X		X		X

\*IT earthing system: No ground monitoring (e. g. Norway). IT Mains adapter cables are labelled with a yellow marking.

## Change mains adapter cable

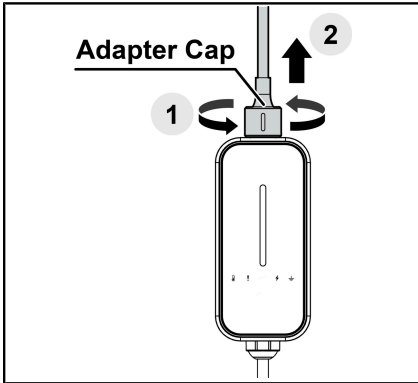

Mains adapter cable can be changed to adapt the specific electrical environment.

Disassemble the mains adapter cable:



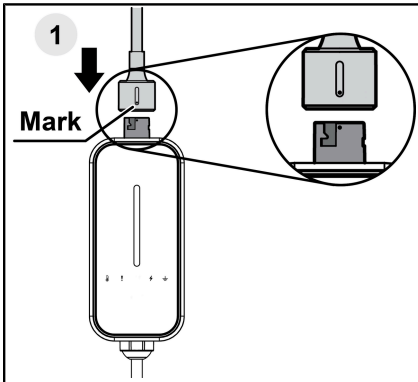





1. Rotate the mains adapter cable cap for loosening the plug.
2. Pull the mains adapter cable away.



Assemble the mains adapter cable:

1. Align the mark and insert the plug, the mains adapter cable cap will rotate and lock automatically.
2. Check if adapter is connected completely by pulling the adapter cable cap.

## Status LED information

Symbol	LED Indicator	Status	Description
	All	All black	Power off
	Charging status bar	Blink orange	Charger self-test
	Charging status bar	Blue	Charger standby/ready for charging
	Charging status bar	Blink blue	Charging
	Temperature	Red	Over temperature protection
	Internal error	Red	Control pilot error, output over current
	Internal error	Blink red	Self-test failed, relay fault
	Mains voltage	Red	Input under/over voltage
	Ground detection	Red	Ground disconnection for TT/TN earthing system
	Ground detection	Orange	Ground detection off for IT earthing system*

\*Illuminates orange constantly when using IT mains adapter cable.

# Installation (Optional accessory)

## Wall mounting overview

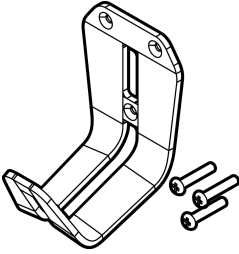

Cable holder and  
3 x Wood screw

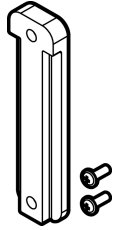

Bracket and  
2 x Hex screw

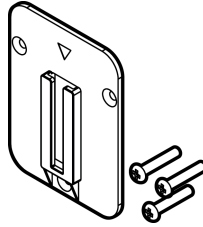

Wall kit and  
3 x Wood screw

## Wall mounting installation

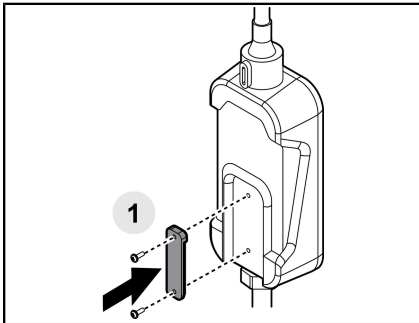

1. Mount the bracket on Flexible Fast Charger with Hex screws

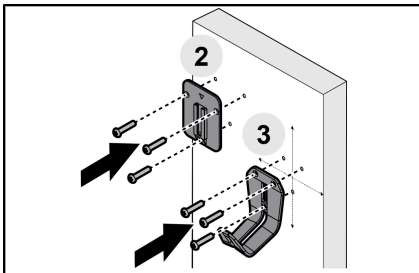

2. Mount the wall kit on the wall\* with wood screws

3. Mount the cable holder to the wall\* with wood screws



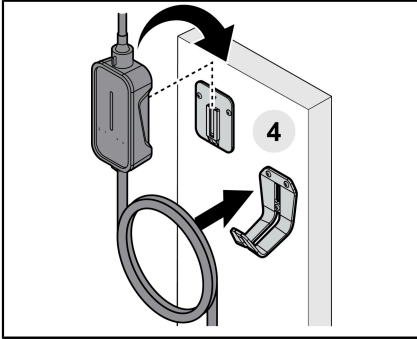

\*Note: location depends on legal requirements and customer requirements where to place it especially.



4. Secure Flexible Fast Charger and the cable on the wall

## Troubleshooting

Contact the local dealer or customer support if the product appears to be functioning abnormally or if the LED indicators display a permanent fault status. DO NOT open the housing or remove any permanently affixed parts. DO NOT tamper with electric protection devices.

Situation	Action
LED Indicator does not light up	<ol style="list-style-type: none"> <li>1. Check the socket and make sure the mains adapter is fully connected. If the socket outlet appears to be damaged, please call a qualified electrician.</li> <li>2. Replug and power up Flexible Fast Charger again or try another suitable outlet.</li> <li>3. If problem persists, contact your dealer or customer support.</li> </ol>
Temperature  indicator illuminates red	Check the socket outlet and protect the charging equipment from direct sunlight or increased temperatures.
Internal error  , Mains voltage  or Ground monitoring  indicator flashes red or is permanently illuminated	<ol style="list-style-type: none"> <li>1. Wait for at least 10 seconds. The product tries to resolve the error and return to normal operation automatically.</li> <li>2. If the product remains in the error mode, please perform a manual restart. Please check the safety guide or the section below.</li> <li>3. If the ground monitoring indicator is permanently illuminated, please call a qualified electrician to check the ground connection. If the mains voltage indicator is permanently illuminated, please call a qualified electrician or your power grid operator.</li> <li>4. If the situation persists, contact the dealer or the customer support.</li> </ol>



## **Manual restart**

1. Disconnect the Flexible Fast Charger from the vehicle by unplugging the vehicle connector
2. Disconnect the Flexible Fast Charger from the mains supply by unplugging the device from the socket outlet
3. Wait for at least 5 seconds
4. Reconnect the Flexible Fast Charger to the mains supply and wait for the completion of the charger self-test
5. Reconnect the Flexible Fast Charger to the vehicle and check if the charging process is starting

## Environmental specifications

Frequency	50/60Hz
Humidity	2% to 95% relative humidity, non-condensing
Altitude	3000m
Operating temperature	-40 °C to + 50 °C
Storage temperature	-40 °C to + 80 °C
IP Protection class	IP67

## Disposal



Flexible Fast Charger is an electronic device and must be disposed of separately from normal house wastes. Please have it disposed in compliance with the waste disposal and recycle local regulation.

## Certification/Compliance



**EN17186:** The product complies to EN 17186:2019

**CE declaration:** The complete CE declaration of conformity for this product can be downloaded from the internet at <https://www.bmw.com/supportflexiblefastcharger>

